

GOKULA KRISHNA COLLEGE OF PHARMACY

HEI CODE: C-26844

NAAC DVV

CYCLE I



7 : INSTITUTIONAL VALUES AND BEST PRACTICES

7.1 Institutional Values & Social Responsibilities

7.1.3 Quality Audits on Environment and Energy undertaken by the Institute

7.1.3(4) Energy Audit Report



Approved by PCI, New Delhi, Government of AP & Affiliated to JNTUA
Recognized by UGC U/S 2(f), An ISO 9001:2015 Certified Institution

Behind RTC Depot, Sullurupeta, Tirupati Dist, Andhra Pradesh - 524121

☎ 9948990116

🌐 www.gkcp.edu.in

✉ gkcpsp@rediffmail.com

CERTIFICATE OF COMPLETION

This is to certify that

Gokula Krishna College of Pharmacy

has successfully completed

CARBON FOOTPRINT & ENERGY AUDIT

The study was completed by Rekhapalli Environmental Solutions & Technologies Pvt Ltd



Dr Rekhapalli Srinivasa Rao

*Green, Eco & Energy Lead Auditor
Certified ISO-14001 Auditor*



Issued by

Rekhapalli Environmental Solutions & Technologies Pvt Ltd

March 2023



Dr. BALAGAN PAVAN KUMAR
M.Pharm, Ph.D, FIC, FGSS, FAGE, FICCP, MISTE
PROFESSOR & PRINCIPAL
GOKULA KRISHNA COLLEGE OF PHARMACY
SULLURPET, TIRUPATI Dt. A.P - 524121

GOKULA KRISHNA COLLEGE OF PHARMACY

SULLURUPETA, TIRUPATI DISTRICT, ANDHRA PRADESH 524121



Carbon Footprint and Energy Audit

Dr. BALAGANI PAVAN KUMAR
M. Pharm, Ph.D, FIC, FBSS, FAGE, FICCP, MISTE
PROFESSOR & PRINCIPAL
GOKULA KRISHNA COLLEGE OF PHARMACY
SULLURPET, TIRUPATI Dt. A.P - 524121



CONTENTS

04 Acknowledgement

05 Executive Summary

07 Carbon footprint & Opportunities

13 Energy efficiency

19 Conclusion



Dr. BALAGANI PAVAN KUMAR
M. Pharm, Ph.D, FIC, FBSS, FAGE, FICCP, MISTE
PROFESSOR & PRINCIPAL
GOKULA KRISHNA COLLEGE OF PHARMACY
SULLURPET, TIRUPATI DL. A.P - 524121

Acknowledgements

REST Pvt Ltd



Dr Rekhapalli Srinivasa Rao
Green, Eco & Energy Lead Auditor
Certified ISO-14001 Auditor

23 March 2023

Carbon Footprint & Energy Audit

The REST Pvt Ltd acknowledges with thanks the cooperation extended to our team for completing the study at Gokula Krishna College of Pharmacy (GKCP).

The interactions and deliberations with GKCP team were exemplary and the whole exercise was thoroughly a rewarding experience for us. We deeply appreciate the interest, enthusiasm, and commitment of GKCP team towards environmental sustainability.

We are sure that the recommendations presented in this report will be implemented and the GKCP team will be further improve their environmental performance.

Kind regards

Your sincerely

Dr Rekhapalli Srinivasa Rao
Green, Eco & Energy Lead Auditor
Certified ISO-14001 Auditor
REST Pvt Ltd



Dr. BALAGANI PAVAN KUMAR
M. Pharm, Ph.D, FIC, FBSS, FAGE, FICCP, MISTE
PROFESSOR & PRINCIPAL
GOKULA KRISHNA COLLEGE OF PHARMACY
SULLURPET, TIRUPATI Dt. A.P - 524121

Executive Summary

The growth of countries across the world is leading to increased consumption of natural resources. There is an urgent need to establish environmental sustainability in every activity we do. In a modern economy, environmental sustainability will play a critical role in the very existence of an organization.

An educational institution is no different. Built environment, especially an educational institution, has a considerable footprint on the environment. Impact on the environment due to energy consumption, water usage and waste generation in an educational institute is prominent. Therefore, there is an imminent need to reduce the overall environmental footprint of the institution.

As an Institution of higher learning, Gokula Krishna College of Pharmacy (GKCP) firmly believes that there is an urgent need to address the environmental challenges and improve their environmental footprint.

True to its belief, GKCP has installed quantity of 280kWA solar powered panels and installed LED lights, REST Pvt Ltd team congratulates GKCP team for their efforts.

Keeping GKCP work in energy efficiency, we recommend the following to be taken by the competent team at GKCP:

Work towards achieving carbon neutrality: INDC emphasizes creating an additional carbon sink of 2.5 to 3 billion tonnes of CO₂ equivalent through additional forest and tree cover by 2030. GKCP's net carbon emission for the year 2021-22 is >50MT CO₂e. GKCP should focus on energy efficiency, renewable energy, and carbon sequestration as tools that will enable them to offset the present carbon emissions and achieve carbon neutrality.

Installation of solar rooftop: Renewable energy plays a very important role in improving the environmental footprint of an organization. By increasing the share of renewable energy in GKCP's energy portfolio, the overall carbon footprint of the college can be reduced. The roof area available at GKCP is around 19324sq.ft on roof top. For the available area, roof top occupied with 280 kWp of solar PV Installed. As an initial step, GKCP could look at installing 25kWp of solar PV which can generate 40,500 units per year. Still the renewable share will also reduce the 33 MT CO₂e. For the current assessment year power consumption to reduce, roof top can be utilized for solar power to expand.

Increase the operating power factor: Presently, based on the energy bills, it is understood that the institution maintains a power factor of 0.65. Since the institution pays electricity bills for the KVAH consumed, the lower the power factor, higher is the energy bill for the same KWH consumption. It is recommended to install capacitor banks to improve the power factor and save energy bill. GKCP can save up to Rs. 20,000 per month.

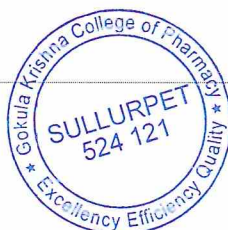

Dr. BALAGANI PAVAN KUMAR
M. Pharm, Ph.D., FIC, FESS, FAGE, FICOP, MISTE
PROFESSOR & PRINCIPAL
GOKULA KRISHNA COLLEGE OF PHARMACY
SULLURPET, TIRUPATI Dt. A.P - 524121

Improve energy efficiency of the college: It is recommended to adopt latest energy efficient technologies for reducing energy consumption in fans, lighting, and air conditioners. We recommend the following projects to be implemented at the earliest:

- Replace conventional 70W ceiling fans with energy efficient BLDC fans of 30W
- Install air conditioners energy savers to save energy in split air conditioners
- Replace all conventional tube lights with LED lamps



DR. BALAGANI PAVAN KUMAR
M. Pharm, Ph.D. FIC, FBSS, FAGE, FICCP, MISTE
PROFESSOR & PRINCIPAL
GOKULA KRISHNA COLLEGE OF PHARMACY
SULLURPET, TIRUPATI DI. A.P - 524121

Carbon Footprint and Energy Audit

Gokula Krishna College of Pharmacy (GKCP) and REST Pvt Ltd are working together to identify opportunities for improvement in energy efficiency and carbon reduction. This report highlights all the potential proposals for improvement through the audit and analysis of the data provided by GKCP for lighting, air conditioning, ceiling fans, and biogas potential.

The report also details the carbon emissions from college operations. For carbon emissions, scope 1 and scope 2 emissions are calculated from the data submitted by GKCP. The report emphasizes the GHG emission reduction potential possible through a reduction in power consumption.

Submission of Documents

"Carbon footprint and energy audit at GKCP was carried out with the help of data submitted by GKCP team. GKCP team was responsible for collecting all the necessary data and submitting the relevant documents to REST Pvt Ltd for the study.

Note

Carbon footprint and energy audit are based on the data provided by GKCP team and discussions the REST Pvt Ltd team had with GKCP team. The scope of the study does not include the exclusive verification of various regulatory requirements related to environmental sustainability.

REST Pvt Ltd has the right to recall the study if it finds (a) major violation in meeting the environmental regulatory requirements by the location and (b) occurrence of major accidents, leading to significant damage to ecology and environment.



Pavan

Dr. BALAGANI PAVAN KUMAR
M. Pharm, Ph.D, FIC, FBSS, FAGE, FICCP, MISTE
PROFESSOR & PRINCIPAL
GOKULA KRISHNA COLLEGE OF PHARMACY
SULLURPET, TIRUPATI Dt. A.P - 524121

Opportunities for improvement

As a part of the overall environmental improvement study at GKCP, carbon footprint calculations were also carried out. The objective of calculating the carbon footprint of the campus is find the present level of emissions from campus operation and what initiatives that the GKCP can take to offset the emissions. By offsetting the emissions, the college can become carbon neutral in the future by adopting energy efficient processes, increase in renewable energy share and tree plantation.

Carbon footprint calculations:

To help delineate direct and indirect emission sources, improve transparency, and provide utility for different types of organizations and different types of climate policies and business goals, three "scopes" (scope 1, scope 2, and scope 3) are defined for GHG accounting and reporting purposes.

For calculating carbon footprint of the campus, Scope 1 & Scope 2 emissions are being considered. Since day scholars use college provided transportation and hostellers stay in campus, Scope 1 and Scope 2 are the highest contributor to overall emissions. For this reason, Scope 3 is not being calculated.

Scope 1: Direct GHG Emissions

Direct GHG emissions occur from sources that are owned or controlled by the company, for example, emissions from combustion in owned or controlled DG sets, canteen, vehicles, etc.; emissions from chemical production in owned or controlled process equipment. Direct CO2 emissions from the combustion of biomass shall not be included in scope 1 but reported separately.

GKCP Scope 1 emissions for 2022-23:

Sources of Scope 1 emissions in GKCP:

- 1) Diesel used for college-owned transportation: 42,320 liters/year
- 2) Diesel consumption for the generator for the assessment year 2022-23 is minimum (included in above consumption).
- 3) LPG used for canteen: 180 cylinders/year

Scope 2: Electricity Indirect GHG Emissions



Balagan Pavan
Dr. BALAGAN PAVAN KUMAR
M. Pharm, Ph.D, FIC, FBSS, FAGE, FICCP, MISTE
PROFESSOR & PRINCIPAL
GOKULA KRISHNA COLLEGE OF PHARMACY
SULLURPET, TIRUPATI Dt. A.P - 524121

Scope-1 Emissions

S.No	Fuel Type	Description	Activity data	Units	CO2 eq. emissions (Tons)
1	LPG	Canteen	0.34	MT	1.04
2	Diesel	Transportation	42.3	KL	112

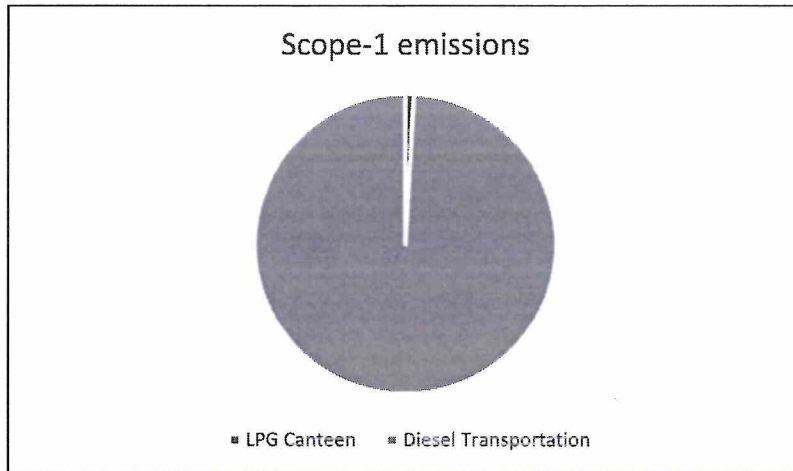

Scope 2 accounts for GHG emissions from the generation of purchased electricity consumed by a company. Purchased electricity is defined as electricity that is purchased or otherwise brought into the organizational boundary of the company. Scope 2 emissions physically occur at the facility where electricity is generated.

GKCP Scope 2 emissions for 2023: Electricity purchased from grid is 156835 units.

Scope-2 Emissions		
Electricity Purchased from grid	29	MT CO2 eq

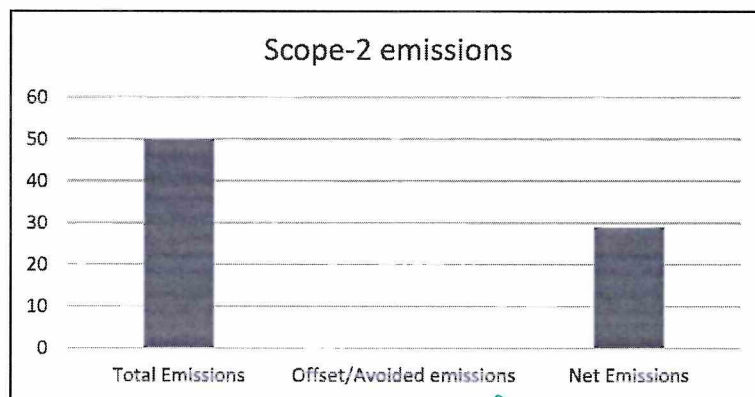

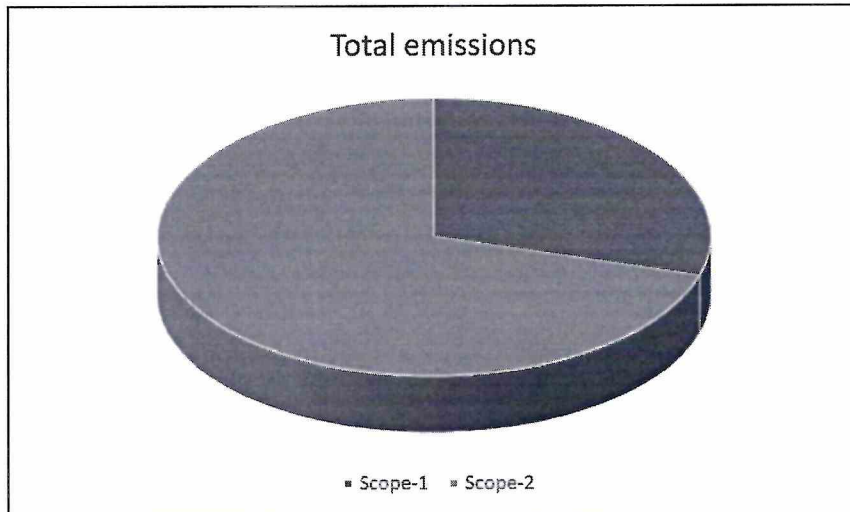

Develop a roadmap to increase contribution of renewable energy in the overall energy consumption

To have a continued focus on increasing renewable energy utilization to 100% which will also lead to reduction in GHG emissions, it is suggested to develop a detailed roadmap on RE utilization. The road map should broadly feature the following aspects -

- Renewable energy potential of GKCP and the maximum offset that can be achieved at GKCP
- Percentage substitution with renewable energy that GKCP wants to achieve in a specified time frame

Key tasks that need to be executed to achieve the renewable energy target

- Specific financial break up for each of the projects highlighting the amount required, available and the utilization status as on date
- A regular review mechanism to ensure progress along the lines of the roadmap should be framed
- The roadmap should also highlight important milestones/key tasks, anticipated bottle GKCP & proposed

Renewable energy roadmap should be used as a base to frame GHG emissions reduction target

It is suggested to use the developed renewable energy roadmap to correlate the GHG reduction that each of the renewable energy project will achieve. This approach will provide a base to set targets for reduction in GHG emissions. The action plan for renewable energy will shoulder the action plan for GHG emissions reduction and work towards achieving carbon neutrality.



Pavan

Dr. BALAGANI PAVAN KUMAR
 M. Pharm, Ph.D, FIC, FBSS, FACE, FICCP, MISTE
 PROFESSOR & PRINCIPAL
 GOKULA KRISHNA COLLEGE OF PHARMACY
 SULLURPET, TIRUPATI Dt. A.P - 524121

Explore the option of other onsite and offsite renewable energy projects

The renewable energy field has been witnessing many private investors due its increased market demand and attractive policies in many states. There are Renewable Energy Independent Power Producers (RE IPPs) who have installed RE based power plants like wind, small hydro and solar PV. GOC can consider having a long-term power purchase agreement with these RE IPPs in purchasing fixed quantity of power for a period of 5 to 10 years.

"Evolve a system to monitor the implementation of various GHG mitigation opportunities GKCP has an action plan to reduce its GHG emissions. GKCP should also evolve a system to monitor the implementation of various GHG mitigation opportunities. It is recommended to use a Gantt chart to mark out the action plan for the activities and track its implementation. Gantt chart will serve as an excellent way to instantly monitor and comprehend all different tasks in one place which would ease tracking of implementation.

Calculation for Installation of 25 kWp of Solar PV in GKCP campus

Renewable energy is one of the important steps to be taken up by the college to reduce their overall carbon footprint. Based on the details provided by GKCP team, The roof area available at GKCP is around 19324sq.ft on roof top. For the available area, roof top occupied with 280 kWA of solar PV Installed. As an initial step, GKCP could look at installing 25kWp of solar PV which can generate 40,500 units per year. However, for report calculation, only 25 kWp capacity is considered.

A renewable energy capacity of 25 kW of solar panel may be installed can generate 40,500 units of electricity per year. Additionally, 25 kWp of solar rooftop can offset 33 MT CO₂e per annum. RESCO model for solar rooftop installation:

A Renewable Energy Service Company (RESCO) is an ESCO Energy service company which provides energy to the consumers from renewable energy sources. RESCO or BOOT model is about pay as Ju consume the electricity.

- Solar Power Plant is owned by the RESCO or Energy Company
- Customer must sign a Power purchase Agreement (PPA) with actual investor at mutually agreed tariff and tenure
- Customer only pays for electricity consumed
- RESCO developer is responsible for its annual operations & maintenance (O&M)
- The RESCO gets the benefit by selling the surplus power generated to the DISCOM

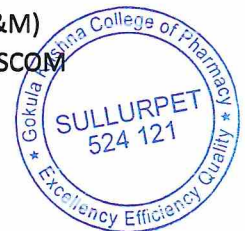

Pavan

Dr. BALAGANI PAVAN KUMAR
M. Pharm, Ph.D, FIC, FBSS, FAGE, FICCP, MISTE
PROFESSOR & PRINCIPAL
GOKULA KRISHNA COLLEGE OF PHARMACY
SULLURPET, TIRUPATI Dt. A.P - 524121

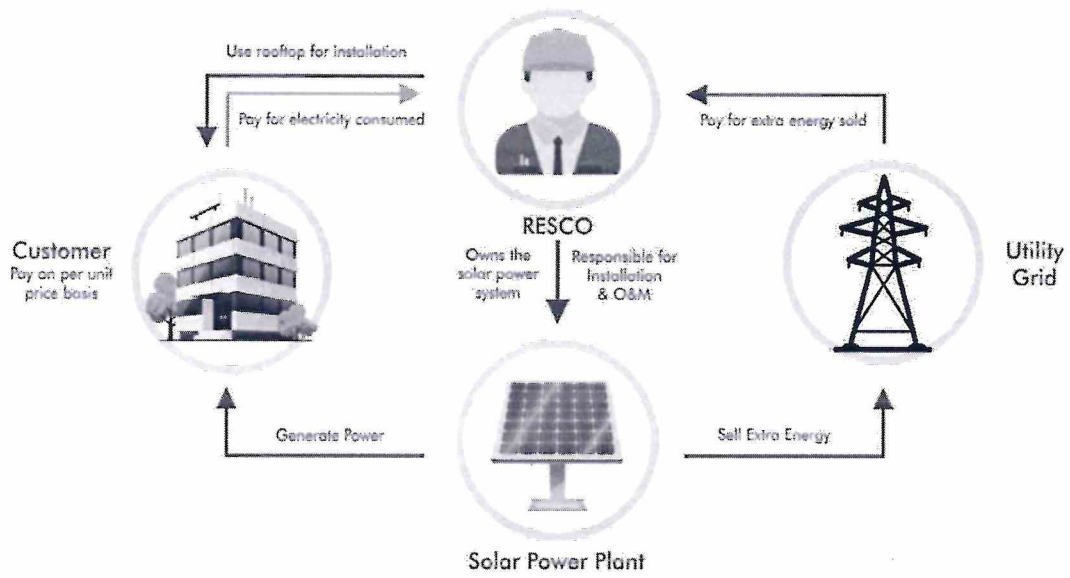

Source: www.bluebirdsolar.com



Pavan

Dr. BALAGANI PAVAN KUMAR
 M. Pharm, Ph.D, FIC, FBSS, FAGE, FICCP, MISTE
 PROFESSOR & PRINCIPAL
 GOKULA KRISHNA COLLEGE OF PHARMACY
 SULLURPET, TIRUPATI Dt. A.P - 524121

Energy Efficiency

Annual energy consumption of GKCP campus is from 156835. There are major blocks in the campus which consumes energy for their operation. Major energy consumers are:

1. Fans
2. Air conditioners

Replace conventional tube lights with LED lamps

Replace Conventional Ceiling Fans with Energy Efficient BLDC Fans

During the Energy Audit at GKCP, a detailed study was carried out to identify the potential for replacing the existing ceiling fans with BLDC super fans. There is 11.2kW power consumption by fans operating in GKCP campus.

Instead of conventional ceiling fans, latest technology BLDC fans which consume only 30W can be installed in the newly constructed building. A brushless DC (BLDC) motor is a synchronous electric motor powered by direct-current (DC) electricity and having an electronic commutation system, rather than a mechanical commutator and brushes. A BLDC motor has an external armature called the stator, and an internal armature called the rotor.

The rotor can usually be a permanent magnet. Typical BLDC motor-based ceiling fan has much better efficiency and excellent constant RPM control as it operates out of fixed DC voltage. The proposed BLDC motor and the control electronics operate out of 24V DC through an SMPS having input AC which can vary from 90V to 270V. The operational block diagram of a BLDC motor is as follows:

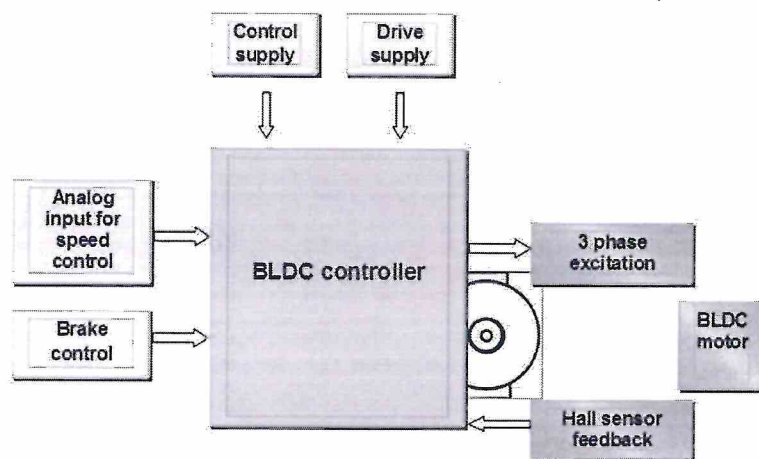

Pavan
Dr. BALAGANI PAVAN KUMAR
M. Pharm, Ph.D, FIC, FBSS, FAGE, FICCP, MISTE
PROFESSOR & PRINCIPAL
GOKULA KRISHNA COLLEGE OF PHARMACY
SULLURPET, TIRUPATI Dt. A.P - 524121

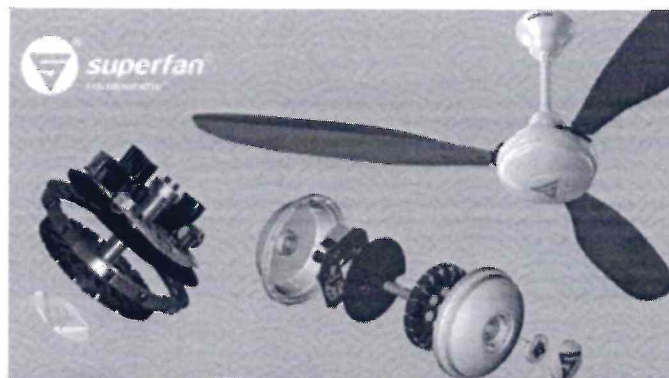

With the replacement of existing ceiling fans with Super Fans the energy consumption is likely to reduce by 55% per fixture. Considering 100 fans being replaced with super-efficient BLDC fans, 3.50 kW can be saved. Considering the average operating hours to be 2000 and unit cost as Rs.

9.0, the calculations are as follows:

Total power consumption by fans in college :	106 x 80kW = 8.48kW
No. of fans considered for calculation :	100 (First cycle of change)
Energy consumption per fan :	80 W
Total energy consumption of fans :	80W X 100 fans
	8 kW
super-efficient BLDC fans energy consumption:	30 W
Savings from 80W to 30 W :	55%
Total savings in fans energy consumption :	55% of 8kW
	4.4 kW
Savings per year :	4.4 kW x 2000 hrs X Rs. 9.0/unit
	Rs. 0.792 Lakhs
Investment :	Rs. 2, 50,000
	38 months

Annual emission reduction potential in case of replacing 50% fans : 20MT CO₂



Pavan
Dr. BALAGANI PAVAN KUMAR
 M. Pharm, Ph.D, FIC, FBSS, FAGE, FICCP, MISTE
 PROFESSOR & PRINCIPAL
 GOKULA KRISHNA COLLEGE OF PHARMACY
 SULLURPET, TIRUPATI Dt. A.P - 524121

Install Air conditioners energy saver for spilt air conditioners:

Present status: As per the data obtained from GKCP team, the campus has majorly 6 Ton of Refrigeration units installed.

Recommendation:

We recommend installing "Airtron", an energy saver that can be installed at every individual unit of AC. The Airtron is the world's most advanced AC SAVER, with all the controls of a Precision AC. The Airtron's dual sensors reference the Room and Coil & Ambient Temp, and uses complex, multiple algorithms in a "closed-loop circuit" to reduce the Compressor Run-Time, to ensure the high savings while maintaining and displaying the Set temperature accurately. The Airtron is Programmable for geographical location and climate and adapts automatically to changes in season and ambient conditions.

This unique device has been developed on Patent-Published technology and approved by leading MNC'S, PSU'S and Govt. Departments. The Airtron is validated by EESL (Energy Efficiency Services Ltd.), Ministry of Power, Government of India, for 44% savings. The Airtron has been validated on all AC's- Inverters, 5 Star, Splits, Multi-Splits, Packages, ducts, Windows, Cassettes from 1.0 - 20.0 TR, LG Ltd, Videocon Ltd, Tata Communications, L&T, Nestle, Ashok Leyland etc. The AIRTRON comes with a Remote for setting the Room Temperature, and in a Non-Flammable Polycarbonate Enclosure, with SMPS Power Supply, to tolerate wide Voltage and Current fluctuations, Surges, Spikes and Sags.

In our case, Airtron installation can reduce the energy consumption of each fixture by 15% on a conservative basis. For a total energy consumption, for air conditioners, as 20 units per hour, 3 units per hour can be saved. It is recommended to install Airtron energy saver in a phase wise manner preferably in the batches of 10 units.

Saving Calculation: Considering the operating hours to be 2000 and unit cost as Rs 9.0/-.

- Monetary annual savings : Rs 45,000/-
- Total investment : Rs 80,000/-
- Payback period : 22 months (2 years)
- Annual emission reduction potential: 4.92 MT CO2



Pavan

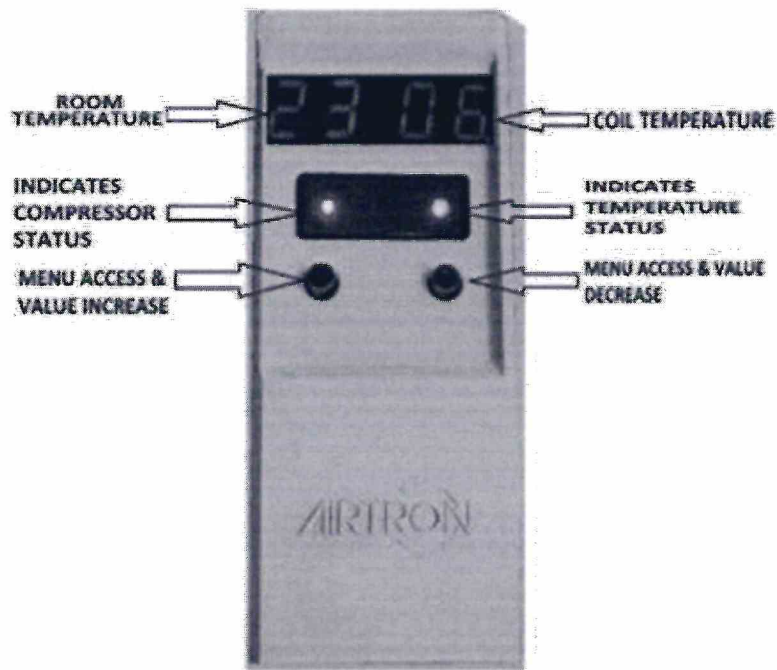

Replace Conventional Lamps with LED Lamps

As per the data submitted, the total number of all the lighting bulbs & fixtures installed are

- 1. LED Tube Lights : 0 Watts
- 2. LED bulbs : 7 x 40Watts = 0.28kW
- 3. Lights : 226 x 40Watts = 9kW

Under failure replacement policy, at least 130 lamps can be changed in the first year.

Types of fixtures	36W Tube
No of fixtures	130
No of hours in Operation	2000

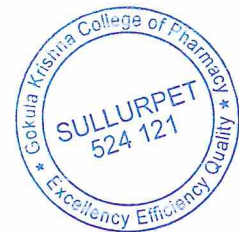

The campus should be keen in harnessing the day lighting available thereby reducing the use of artificial lighting.

Based on the occupancy, monitoring should be ensured to reduce excessive consumption of energy.

Pavan

Major savings in energy through lighting fixtures can be achieved by replacing all the above existing fixtures with LED's meeting the required LUX levels. The LED's being less energy consuming while maintaining the equivalent lux is the more sustainable option. The replacement of lighting fixtures should be done as per failure replacement policy i.e. change the old fixture with LED when it fails

Advantages of LED

- **Lower energy consumption:** The energy consumption of LEDs is low when compared to the other conventional sources for the same amount of Lumen output.

Performance comparison of different type lights

Type of Lamp	Lumen/Watt	CRI	Life hours
HPSV lamps	90-120	Bad (22-25)	15,000-20,000
Metal Halide lamps	65-100	Good (65-90)	18,000
LED lamps	100-150	Very Good (>80)	10,000-12,000

- **High S/P ratio:** LEDs have higher scotopic/photopic ratio (S/P ratio). The eye has two primary light sensing cells called rods and cones - cones function in day light and process visual information whereas rods function in night light. The cone dominated vision is called photopic and the rod dominated vision is called scotopic. The S/P ratio indicates the measure of light that excites rods compared to the light that excites cones. In office environments, illumination is more effective if the S/P ratio is high as it is under scotopic region. LEDs hence are ideally suited for these applications as they have a high S/P ratio.
- **Longer life-time:** LEDs have longer life time of around 1,00,000 hours. This is equivalent to 11years of continuous operation or 22 years of 50% operation.
- **Faster switching:** LED lights reach its brightness instantly upon switching and can frequently be switched on/off without reducing the operational life expectancy.
- **Greater durability and reliability:** As LEDs are solid-state devices and uses semi-conductor material; they are sturdier than conventional sources that use filaments or glass. LEDs can also withstand shock, extreme temperatures and vibration as they don't have fragile materials as components.
- **Good Colour Rendering Index (CRI):** The colour rendering index, i.e., measure of a light sources' ability to show objects as perceived under sunlight is high for LEDs. The CRI of natural sunlight is 100 and LEDs offer CRI of 80 and above.

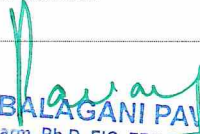

Dr. BALAGANI PAVAN KUMAR
 M. Pharm, Ph.D, FIC, FBSS, FAGE, FICCP, MISTE
 PROFESSOR & PRINCIPAL
 GOKULA KRISHNA COLLEGE OF PHARMACY
 SULLURPET, TIRUPATI Dt. A.P - 524121

LED offers more focused light and reduced glare. Moreover, it does not contain pollutants like mercury. LED technology is highly compatible for solar lighting as low-voltage power supply is enough for LED illumination.

Calculations are as follows:

Existing Lighting fixtures	36W
Existing power consumption(kW)	4.5kW (130lamps)
Proposed LED wattage (W)	15
LED power consumption (kW)	1.95kW
Energy saving (kW)	2.55kW
Operating hours	2000

Annual monetary savings : Rs 38,250/-
Investment needed : Rs 90,000/-
Payback period : 2.5 years
Annual Emission reduction potential : 4.18MT of CO₂.



Pavani

Dr. BALAGANI PAVAN KUMAR 18 | Page
M. Pharm, Ph.D, FIC, FBSS, FAGE, FICCP, MISTE
PROFESSOR & PRINCIPAL
GOKULA KRISHNA COLLEGE OF PHARMACY
SULLURPET, TIRUPATI Dt. A.P - 524121

Conclusion

GKCP has initiated few energy efficiency activities in their campus. While REST Pvt Ltd appreciates the GKCP team for their efforts, we would like to emphasize that opportunity exists further reduce the energy consumption. Installation of renewable energy is to be given major focus. RESCO model can be adopted to install renewable energy without upfront capital investment. We in REST Pvt Ltd are sure that all the recommendations mentioned in the report will be implemented by GKCP team and the overall environmental performance of the campus will be improved.



A handwritten signature in green ink, appearing to read "Balagan" or similar, written over a horizontal line.

Dr. BALAGANI PAVAN KUMAR
M. Pharm, Ph.D, FIC, FBSS, FAGE, FICCP, MISTE
PROFESSOR & PRINCIPAL
GOKULA KRISHNA COLLEGE OF PHARMACY
SULLURPET, TIRUPATI Dt. A.P - 524121